



User Manual

ATLONA

HDMI™ 1.3 EXTENDER WITH BI-DIRECTIONAL IR UP TO 200FT AT-HD-BIR40SR



TABLE OF CONTENTS

1. INTRODUCTION	3
2. FEATURES	3
3. PACKAGE CONTENTS	4
4. SPECIFICATIONS	5
5. PANEL DESCRIPTIONS	6
5.1. Transmitting Module	6
5.1.1. Front Panel	6
5.1.2. Rear Panel	6
5.2. Receiving Module	7
5.2.1. Front Panel	7
5.2.2. Rear Panel	7
6. IR PASS-THROUGH	8
6.1 IR Extenders	8
6.2 IR Sockets	8
6.3. Definition of IR Earphone Jack.	8
6.4 Supported IR Data Format.	9
7. INSTALLATION	10
8. RJ45 / CAT5 PIN DEFINITION	11
9. CONNECTION DIAGRAM	12
10. NOTICE	13
11. PERFORMANCE GUIDE	14
12. ATLONA PRODUCT REGISTRATION	14
13. SAFETY INFORMATION	15
14. WARRANTY	16

INTRODUCTION:

Atlona Technologies AT-HD-BIR40SR HDMI™ v1.3 Extender with Bi-directional IR boosts your audio/video transmission distance up to 200ft (60m) in HDTV 1080i format, 130ft (40m) in HDTV 1080p format, and 65ft (20m) in HDTV 1080p with 36 bit color depth. With two cost effective solid Cat-5/5e/6 UTP/STP cable, users can readily extend HDTV sources from DVD players, Blu-ray Disc player, PS3, PC, and any other kinds of sources compliant with TMDS to distant display monitors including HDMI™ or DVI enabled TV sets or LCD PC monitors. The AT-HD-BIR40SR also features with embedded IR input and output on both sender and receiver units so users can control the source device or HDMI™ display at remote site via IR remote in di-directional IR pass-through.

The AT-HD-BIR40SR includes two units: Sender unit and Receiver unit. The Sender unit sends the HDMI™ or DVI signals received from the source device and receives IR signals from the Receiver unit or sends the received IR signal from the Sender unit via two low cost Cat-5/5e/6 cables. The Receiver unit is responsible for equalizing the audio/video data received from the sender unit and sends the IR signals received from the IR receiver to the Sender unit or receives IR signals from the sender unit. The transmission distance between the audio/video source and the display can be up to 60m / 200ft under HD resolution (720p/1080i), or 40m / 130ft under Full HD resolution (1080p). With 8-level digital signal equalization control on the receiver unit, users can adjust the signal level equalization scale to the received audio/video signals, and therefore optimize the transmission distance between source and display.

FEATURES:

- HDMI™ 1.3c and HDCP compliant
- Extends the transmission length up to 200ft (60m) from the HDMI™ sources under HD resolution (1080i or 720p at 24-bit color depth)
- Extends the transmission length up to 130ft (40m) from the HDMI™ sources under Full HD resolution (1080p at 24-bit color depth)
- Extends the transmission length up to 65ft (20m) from the HDMI™ sources under Full HD resolution (1080p at 36-bit color depth)
- Minimizes the cable skew by adjustable 8-level equalization rotary control
- Supports half-duplex bi-directional IR pass-through
- Supports full frequency of IR signals from 20kHz to 60kHz
- Purely unaltered uncompressed 7.1ch digital HDMI™ over CAT5/6 cable transmission
- Wall mounting housing design for easy and robust installation

The length depends on the characteristics and quality of the cables. Higher resolutions and longer transmission distances require low skew cables (<25ns/100m) for best performance.

PACKAGE CONTENTS:

- 1x AT-HD-BIR40SR (Transmitting and Receiving Modules)
- 1x IR blaster extension cable
- 1x IR receiver extension cable
- 1x 5V DC power supply unit
- 1x User's manual

SPECIFICATIONS:

Technical		Transmitter	Receiver
3D Support		Yes	Yes
HDMI™ compliance		HDMI™ 1.3c	
HDCP compliance		Yes	
Video bandwidth		Single-link 225MHz (6.75Gbps)	
Video support		480i / 480p / 720p / 1080i / 1080p60 24/30/36-bit color	
HDMI™ transmission [24-bit]		Full HD (1080p) – 130ft (40m) [CAT5e] / 165ft (50m) [CAT6] HD (720p/1080i) – 165ft (50m) [CAT5e] / 200ft (60m) [CAT6]	
Audio support		Surround sound (up to 7.1ch) or stereo digital audio	
Equalization		8-level digital control at receiver	
Input TMDS signal		1.2 Volts [peak-to-peak]	
Input DDC signal		5 Volts [peak-to-peak, TTL]	
ESD protection		[1] Human body – ±19kV (air-gap discharge) & ±12kV (contact discharge) [2] Core chipset – ±8kV	
PCB stack-up		4-layer board [impedance control — differential 100Ω; single 50Ω]	
IR remote control		Electro-optical characteristics: $\tau = 25^\circ$ / Carrier frequency: 20-60kHz	
IR pass-through		Bi-directional	
Input		1x HDMI™ + 1x 3.5mm	2x RJ45 + 1x 3.5mm
Output		2x RJ45 + 1x 3.5mm	1x HDMI™ + 1x 3.5mm
HDMI™ connector		Type A [19-pin female]	
RJ45 connector		WE/SS 8P8C with 2 LED indicators	
3.5mm socket		Blue socket for IR blaster / Green socket for IR receiver	
Rotary control switch		None	Signal level equalization
Mechanical			
Housing		Metal enclosure	
Dimensions [L x W x H]	Model	83 x 74 x 27mm (3.3" x 2.9" x 1.1") for sender / receiver	
	Package	270 x 175 x 80mm (10.6" x 6.9" x 3.1")	
Weight	Model	215g (7.6 oz) for sender / receiver	
	Package	815g (1.8 lbs)	
Fixedness		Wall-mounting case with screws	
Power supply		5V DC either at Sender Unit or at Receiver Unit	
Power consumption		1.5 Watts [max]	
Operation temperature		0~40°C (32~104°F)	
Storage temperature		-20~60°C (-4~140°F)	
Relative humidity		20~90% RH (no condensation)	

PANEL DESCRIPTIONS:

5.1. Transmitting Module

5.1.1. Front Panel

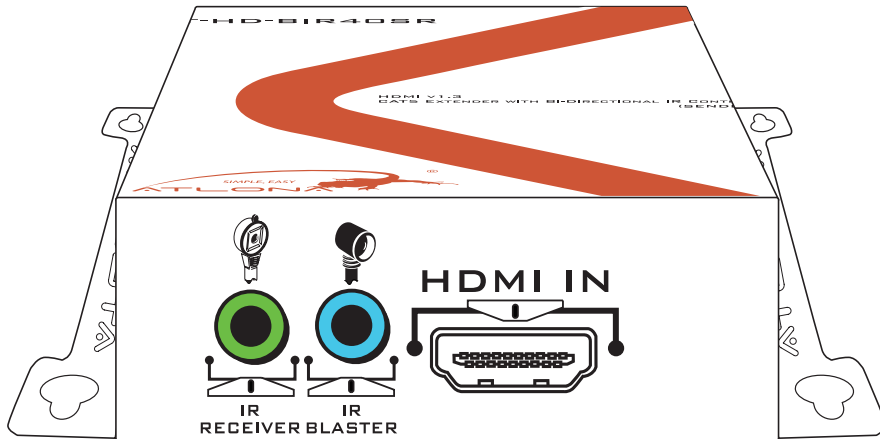

IR RECEIVER: 3.5mm infrared socket for plugging in the extension cable of IR receiver

IR BLASTER: 3.5mm infrared socket for plugging in the extension cable of IR blaster

HDMI IN: Connects to a HDMI source with a HDMI male-male cable

5.1.2. Rear Panel

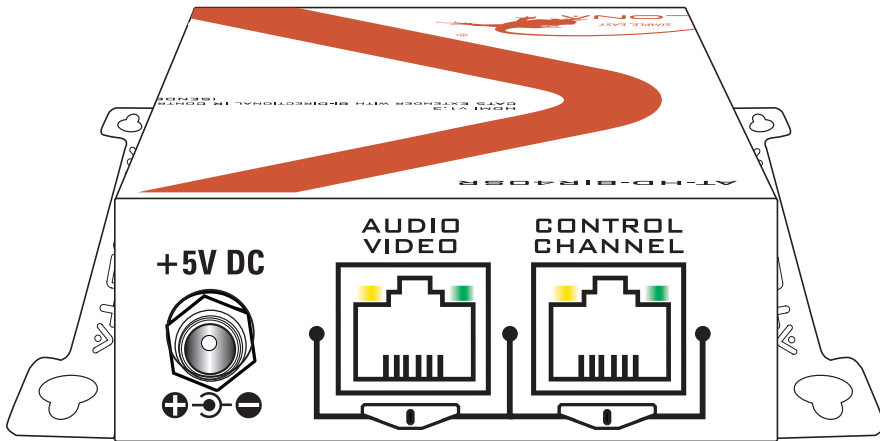

+5V DC: Connect to 5V DC power supply unit either at the Sender Unit or the Receiver Unit. Powered at one end is enough to supply the whole extender set.

AUDIO VIDEO: Connect a Cat-5/5e/6 cable to the AUDIO/VIDEO port on the receiver unit

CONTROL CHANNEL: Connect a Cat-5/5e/6 cable to the CONTROL CHANNEL port on the receiver unit

5.2. Receiving Module

5.2.1. Front Panel

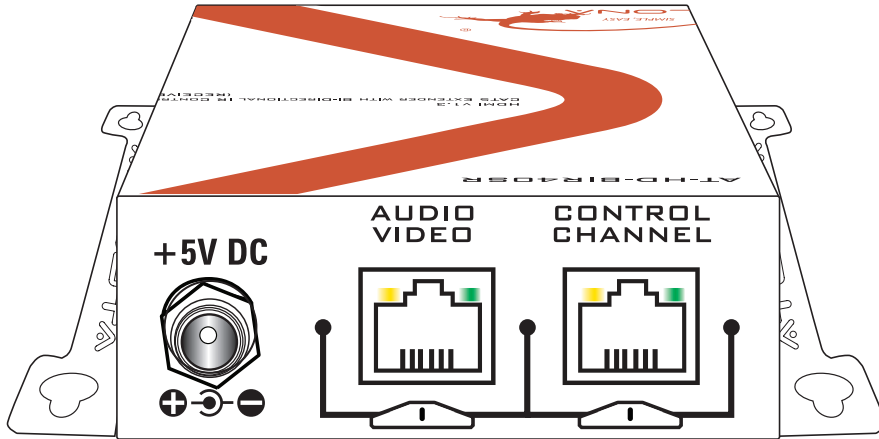

+5V DC: Connect to 5V DC power supply unit either at the Receiver Unit or the Sender Unit. Powered at one end is enough to supply the whole extender set.

AUDIO VIDEO: Connect a Cat-5/5e/6 cable to the AUDIO/VIDEO port on the sender unit

CONTROL CHANNEL: Connect a Cat-5/5e/6 cable to the CONTROL CHANNEL port on the sender unit

5.2.2. Rear Panel

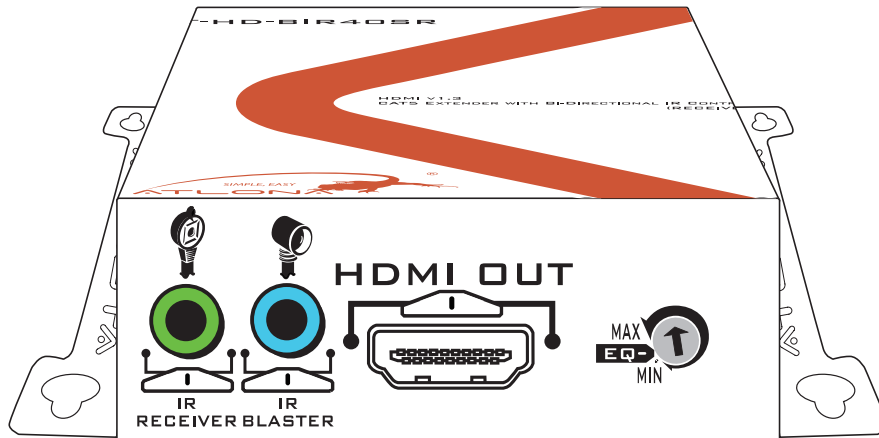

IR RECEIVER: 3.5mm infrared socket for plugging in the extension cable of IR receiver

IR BLASTER: 3.5mm infrared socket for plugging in the extension cable of IR blaster

HDMI OUT: Connects to a HDMI display or projector with a HDMI male-male cable

EQ: Adjust the 8-level signal equalization control to the received HDMI signals. The HDMI signal level varies from MAX (strongest) to MIN (weakest) for respective transmission length from longest possible range to short distance. Dial the EQ from MIN to MAX and stop turning the rotary switch whenever the audio/video is playing normally. Inappropriate signal level setting may cause overpowering issues that would shorten the product's life significantly!

IR PASS-THROUGH:

6.1 IR Extenders

IR Blaster



IR Receiver



6.2 IR Sockets

IR BLASTER: plug in the IR blaster to emit all IR command signals received from the IR receiver from the other end to control the devices corresponding to the IR signals.

IR RECEIVER: plug in the IR receiver to receive all IR command signals from the IR remote controls of the corresponding devices.

CAUTION!

Incorrect placement of IR Blaster and Receiver may result in the failure of the IR extenders. Please check carefully before plugging in the IR extender to the respective IR sockets. Warranty will not cover the damage.

6.3. Definition of IR Earphone Jack.

IR Blaster

- 1. IR Signal [20-60KHz]
- 2. Grounding



IR Receiver

- 1. Power
- 2. IR Signal [20-60KHz]
- 3. Grounding



6.4 Supported IR Data Format.

Data Format	Suitable	Not Recommended
NEC	v	
RC5	v	
TOSHIBA MICOM CODE	v	
GRUNDIG CODE	v	
SONY 12 BIT CODE	v	
SONY 15 BIT CODE	v	
SONY 20 BIT CODE	v	
RCA CODE		v
RCM CODE		v
MATSUSHITA CODE		v
mitsubishi CODE	v	
ZENITH CODE	v	
JVC CODE	v	
M50560-001P	v	
MN6125H	v	
MN6125L	v	
MN6014_C5D7	v	
MN6014-C6D6	v	
MC14457P	v	
LC7464(AHEA)	v	
GEMINI_CM	v	

INSTALLATION:

1. Connect a HDMI™ or DVI source (e.g., a Blu-ray Disc player) to the Transmitting Module.
2. Connect a HDMI™ or DVI display (e.g., a HDTV) to the Receiving Module.
3. Connect two solid Cat-5/5e/6 UTP/STP cable between the Transmitting and Receiving Modules.
4. Make sure these two solid Cat-5/5e/6 UTP/STP cable are tightly connected and not loose.
5. If you want to control the source devices at display side, plug in the IR blaster to the Transmitting Module and the IR receiver to the Receiver Unit. If you want to control the display at source side, plug in the IR receiver to the Transmitting Module and the IR blaster to the Receiving Module.
6. Plug in the 5V DC power supply unit to the latch-locking power jack on either the Sender Unit or the Receiver Unit.
7. If you see flickering or blinking image on the display, adjust the rotary control switch to improve the cable skew. MAX stands for the strongest HDMI™ signal level for longest possible transmission length while MIN stands for the weakest HDMI™ signal level for short transmission length. Try adjusting the signal level from MIN to MAX to find the optimal setting for the HDMI™ over CAT5 transmission.

RJ45 / CAT5 PIN DEFINITION:

Audio/Video Port

Data Link TIA/EIA-568-B		
PIN	Color	Function
1	W-O	TX0-
2	O	TX0+
3	W-G	TX1-
4	BL	TX2-
5	W-BL	TX2+
6	G	TX1+
7	W-BR	TXC-
8	BR	TXC+

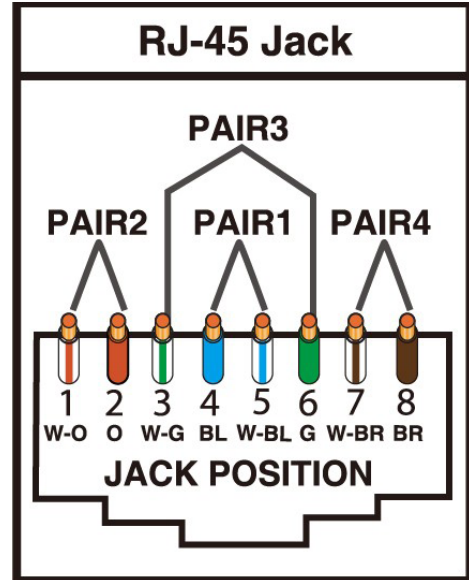

Control Channel Port

Data Link TIA/EIA-568-B		
PIN	Color	Function
1	W-O	IR
2	O	Power
3	W-G	DDC SCL
4	BL	DDC SDA
5	W-BL	GND
6	G	GND
7	W-BR	Power
8	BR	CEC

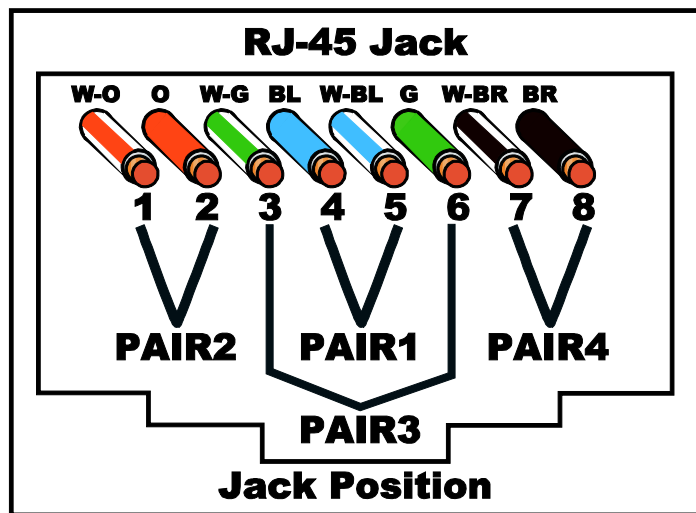

CONNECTION DIAGRAM:

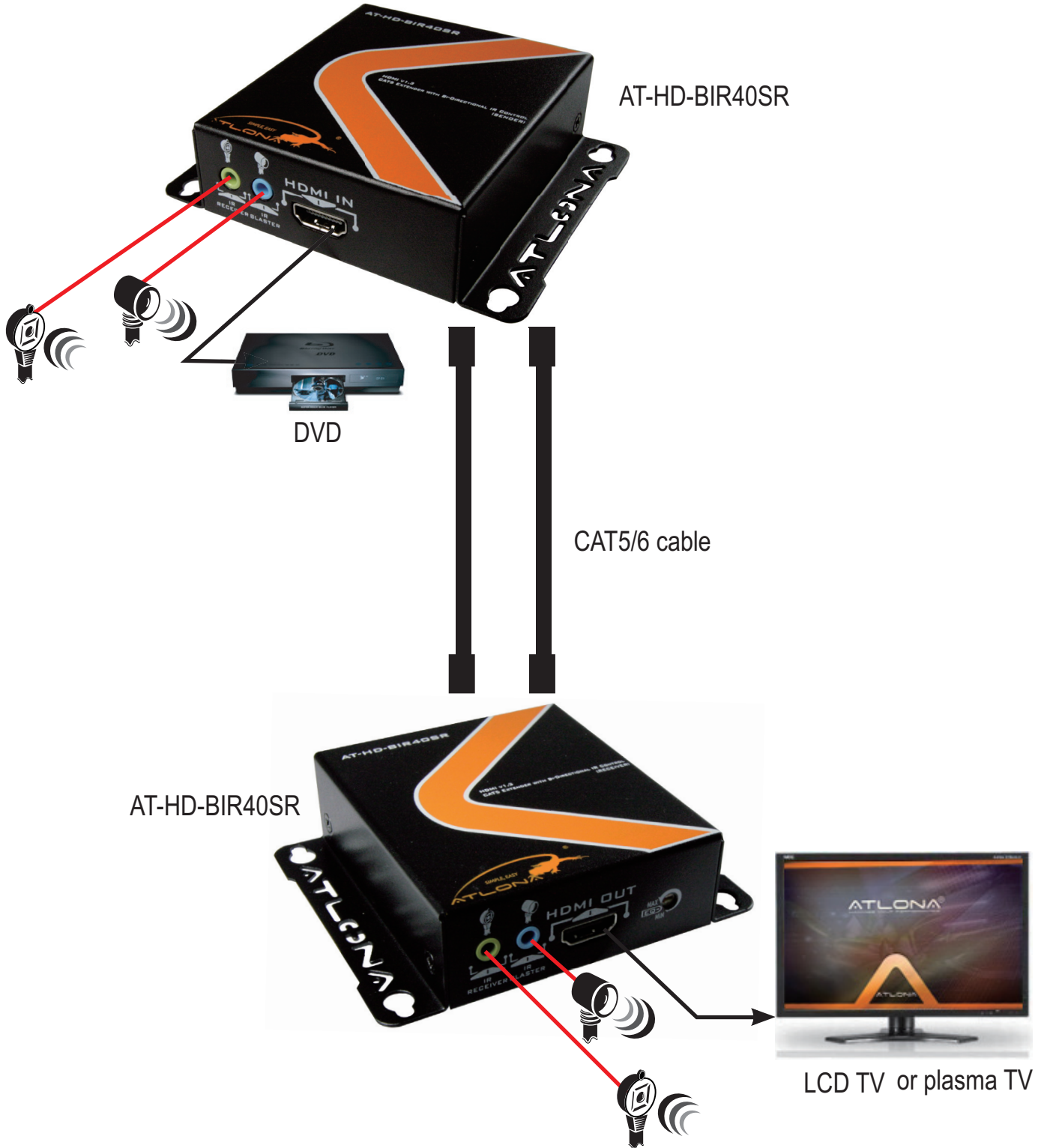

NOTICE:

1. When adjusting the signal level on the receiver unit, please dial the rotary control switch from MIN to MAX and stop turning the rotary switch whenever the audio/video is playing normally. Inappropriate signal level setting may cause overpowering issue that would shorten the product life significantly!
2. If the DVI or HDMI™ device requires the EDID information, please use AT-DVISync EDID Reader/Writer to retrieve and provide DVI or HDMI™ display EDID information.
3. All HDMI™ over CAT5 transmission distances are measured using Belden 1583A CAT5e 125MHz UTP cable and ASTRODESIGN Video Signal Generator VG-859C.
4. The transmission length is largely affected by the type of Cat-5/5e/6 cables, the type of HDMI™ sources, and the type of HDMI™ display. The testing result shows solid UTP cables (usually in the form of 300m [1,000ft] bulk cables) can transmit a lot longer signals than stranded UTP cables (usually in the form of fixed length patch cords). Shielded STP cables are better suited than unshielded UTP cables. A solid UTP Cat-5e cable shows longer transmission range than stranded STP Cat-6 cable. For long extension applications, solid UTP/STP cables are the only viable choice.
5. EIA/TIA-568-B termination (T568B) for Cat-5/5e/6 cables is recommended.
6. To reduce the interference among the unshielded twisted pairs of wires in Cat-5/5e/6 cable, one can use double shielded STP cables to improve EMI problems, which is worsen in long transmission.
7. Because the quality of the category cables has the major effect on how long the transmission limit can achieve and how good is the received picture quality, the actual transmission range is subject to one's choice of Cat-5/5e/6 cables. For desired resolutions greater than 1080i or 1280x1024, a Cat-6 cable is recommended.
8. If your HDMI™ display has multiple HDMI™ inputs, it is found that the first HDMI™ input [HDMI™ input 1] generally can produce better transmission performance among all HDMI™ inputs.

PERFORMANCE GUIDE:

Performance rating		Type of category cable		
Wiring	Shielding	CAT5	CAT5e	CAT6
Solid	Unshielded (UTP)	★★★	★★★★	★★★★★
	Shielded (STP)	★★★	★★★	★★★★
Stranded	Unshielded (UTP)	★	★★	★★
	Shielded (STP)	★	★	★★
Termination		Please use EIA/TIA-568-B termination (T568B) at any time		

ATLONA PRODUCT REGISTRATION:

Thank you for purchasing this Atlona product — we hope you'll enjoy it.

We also hope that you'll take a few moments to register your new purchase. Registration creates an ownership record if your product is lost or stolen and helps ensure you'll receive notification of performance issues and firmware updates. At Atlona, we respect and protect your privacy and assure you that your registration information is completely secure. Of course, Atlona product registration is totally voluntary and failure to register will not diminish your limited warranty rights.

To register go to www.atlona.com/registration

SAFETY INFORMATION:

Safeguards

To reduce the risk of electric shock, do not expose this product to rain or moisture.

If the wall plug does not fit into your local power socket, hire an electrician to replace your obsolete socket.

Do not modify the wall plug.

Doing so will void the warranty and safety features.

This equipment should be installed near the socket outlet and the device should be easily accessible in case it requires disconnection.

Precautions

FCC Regulations state that any unauthorized changes or modifications to this equipment not expressly approved by the manufacturer could void the user's authority to operate this equipment.

Operate this product using only the included external power supply. Use of other power supplies could impair performance, damage the product or cause fires.

In the event of an electrostatic discharge, this device may automatically turn off. If this occurs, unplug the device, and plug it back in.

Protect and route power cords so they will not be stepped on or pinched by anything placed on or against them. Be especially careful of plug-ins, or cord exit points from this product.

Avoid excessive humidity, sudden temperature changes or temperature extremes.

Keep this product away from wet locations such as bathtubs, sinks, laundries, wet basements and swimming pools.

Use only accessories recommended by ATLONA to avoid fire, shock or other hazards.

Unplug the product before cleaning. Use a damp cloth for cleaning. Do not use cleaning fluid or aerosols, which could enter the unit and cause damage, fire or electrical shock. Some substances may also mar the finish of the product.

Never open or remove unit panels or make any adjustments not described in this manual. Attempting to do so could expose you to dangerous electrical shock or other hazards. It may also cause damage to your AT-HD-BIR40SR. Opening the product will void the warranty.

Do not attempt to service the unit. Instead disconnect it and contact your Authorized ATLONA reseller or contact ATLONA directly.

WARRANTY:

1. LIMITED WARRANTY

Atlona Technologies warrants that (a) its products (the "Product") will perform substantially in accordance with the accompanying written materials for a period of 3 years from the date of receipt and (b) that the Product will be free from defects in materials and workmanship under normal use and service for a period of 3 years. In the event applicable law imposes any implied warranties, the implied warranty period is limited to 3 years from the date of receipt. Some jurisdictions do not allow such limitations on duration of an implied warranty, so the above limitation may not apply to Customer.

2. CUSTOMER REMEDIES

Atlona Technologies and its suppliers' entire liability and Customer's exclusive remedy shall be, at Atlona Technologies' option, either return of the price paid for the Product, or repair or replacement of the Product that does not meet this Limited Warranty and which is returned to Atlona Technologies with a copy of Customer's receipt. This Limited Warranty is void if failure of the Product has resulted from accident, abuse, or misapplication. Any replacement Product will be warranted for the remainder of the original warranty period or 3 year, whichever is longer.

3. NO OTHER WARRANTIES

TO THE MAXIMUM EXTENT PERMITTED BY APPLICABLE LAW, ATLONA TECHNOLOGIES AND ITS SUPPLIERS DISCLAIM ALL OTHER WARRANTIES, EITHER EXPRESS OR IMPLIED, INCLUDING, BUT NOT LIMITED TO IMPLIED WARRANTIES OF MERCHANTABILITY AND FITNESS FOR A PARTICULAR PURPOSE, WITH REGARD TO THE PRODUCT AND ANY RELATED WRITTEN MATERIALS. THIS LIMITED WARRANTY GIVES CUSTOMER SPECIFIC LEGAL RIGHTS. CUSTOMER MAY HAVE OTHER RIGHTS DEPENDING ON THE JURISDICTION.

4. NO LIABILITY FOR DAMAGES

TO THE MAXIMUM EXTENT PERMITTED BY APPLICABLE LAW, IN NO EVENT SHALL ATLONA TECHNOLOGIES OR ITS SUPPLIERS BE LIABLE FOR ANY DAMAGES WHATSOEVER (INCLUDING WITHOUT LIMITATION, SPECIAL, INCIDENTAL, CONSEQUENTIAL, OR INDIRECT DAMAGES FOR PERSONAL INJURY, LOSS OF BUSINESS PROFITS, BUSINESS INTERRUPTION, LOSS OF BUSINESS INFORMATION, OR ANY OTHER PECUNIARY LOSS) ARISING OUT OF THE USE OF OR INABILITY TO USE THIS PRODUCT, EVEN IF ATLONA TECHNOLOGIES HAS BEEN ADVISED OF THE POSSIBILITY OF SUCH DAMAGES. IN ANY CASE, ATLONA TECHNOLOGIES' AND ITS SUPPLIERS' ENTIRE LIABILITY UNDER ANY PROVISION OF THIS AGREEMENT SHALL BE LIMITED TO THE AMOUNT ACTUALLY PAID BY YOU FOR THE PRODUCT. BECAUSE SOME JURISDICTIONS DO NOT ALLOW THE EXCLUSION OR LIMITATION OF LIABILITY FOR CONSEQUENTIAL OR INCIDENTAL DAMAGES, THE ABOVE LIMITATION MAY NOT APPLY TO YOU.